



SA 320 SERIES INSTRUCTION MANUAL



Caution / Warning

- Always wear eye protective gear.
- You may be punished if you are shooting for practical jokes.
- Never shoot the gun at places where people and cars pass cross.
- Never aim or shoot a person or animal as a target.
- Never look into the gun muzzle.
- Always direct the muzzle towards a safe direction.
- Avoid pulling the trigger carelessly.
- Please keep your fingers away from the trigger, except when you are ready to shoot a target.
- Always put the gun in a case or bag when you are carrying it.
- Keep out of reach of children.

注意事項/警告

- 始終配戴護目鏡。
- 若隨意用玩具槍開玩笑可能會觸及法律。
- 切勿在有人及汽車經過的地方開槍。
- 切勿將人或動物做為目標射擊。
- 切勿直視槍口。
- 始終將槍口朝向安全位置。
- 避免不小心拉動扳機。
- 除準備射擊目標外，請不要將手指放在扳機上。
- 攜帶槍枝時請將其放在箱子或袋子中。
- 請將本品放在兒童無法觸及的地方。

Specification / 產品諸元

	SA320	SA320 Tactical
• Over all / 全槍長度:	200 mm	210 mm
• Inner Barrel / 內管長度:	97 mm	97 mm
• Weight / 重量:	673g	727g
• Bullet / 彈種:	6 mm BBs	6 mm BBs
• Capacity / 填彈數:	21 Rds	26 Rds
• Energy / 動能:	0.95 Joule	0.95 Joule

Table of Contents / 目錄

Paragraph Number / Title 段落編號 / 標題	Page Number 頁數
---------------------------------------	-------------------

Chapter 1 - Introduction / 章節1-簡介

1-0	Caution and Warning / 注意事項與警告	01
1-1	Component Name / 組件名稱	03
1-2	Optic Mounting Plate Installation / 配件安裝	04

Chapter 2 - Operating Instructions / 章節2-使用說明

2-1	Charging Of Gas / 填充瓦斯	07
2-2	Discharging Of Gas / 釋放瓦斯	08
2-3	Loading The Magazine / 裝填BB彈	09
2-4	Shooting preparation / 射擊前準備	10
2-5	Sights / 瞄準	11
2-6	Shooting / 射擊	11
2-7	Adjustable Shoot Up / HOP-UP彈道調整	12
2-8	Shooting done / 射擊完畢	13

Chapter 3 - Maintenance / 章節3-保養

3-1	Cleaning and Maintenance / 清潔與保養	14
3-2	Trouble Clinic / 故障排除	15

1-1 Component Name / 組件名稱

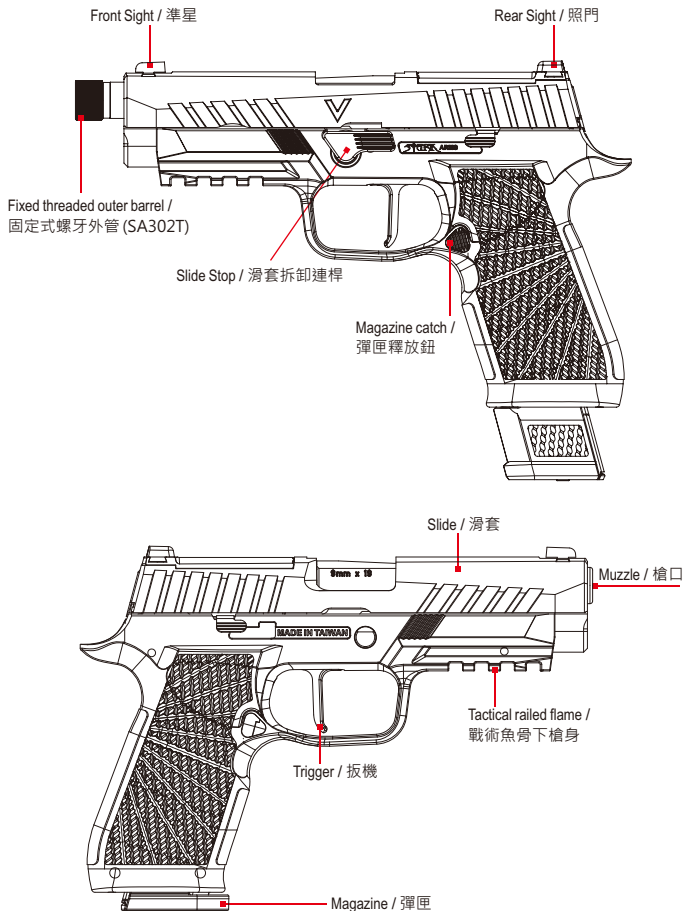

1-2 Optic Mounting Plate Installation / 配件安裝

Remove the gun before attaching the accessories.

加裝配件前務必確認槍支沒上膛、彈匣卸下。

Please turn the screws carefully to avoid slippage.

請小心轉動螺絲，以免出現滑牙的情況。

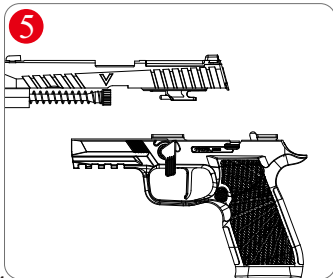
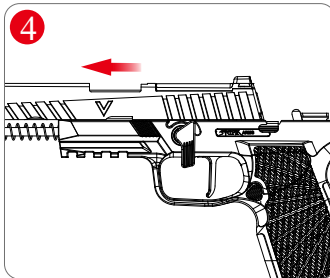
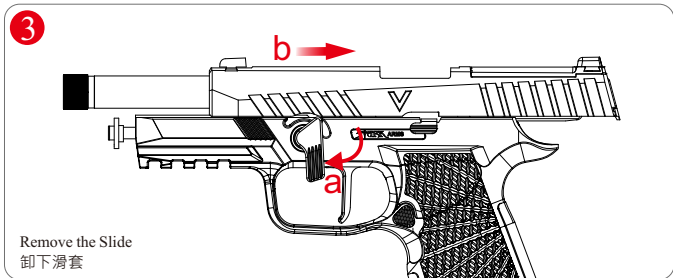
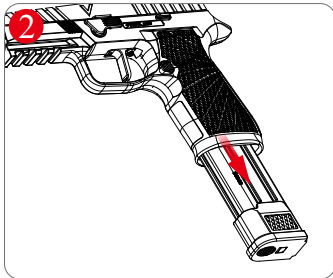
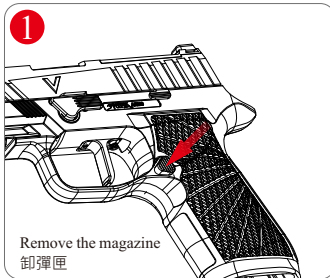

1-2 Optic Mounting Plate Installation / 配件安裝

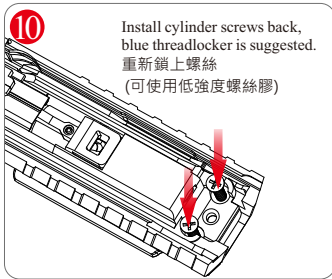
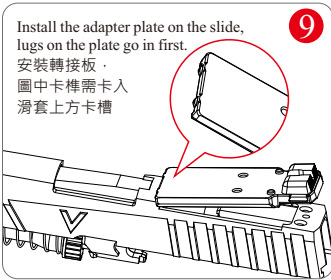
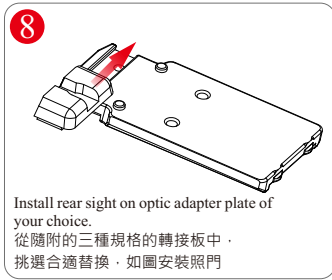
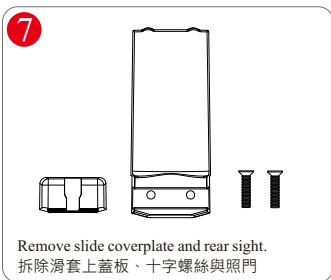
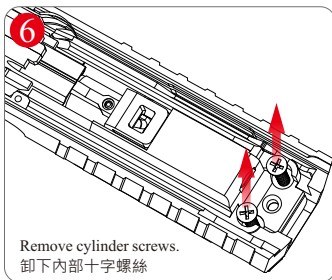

1-2 Optic Mounting Plate Installation / 配件安裝

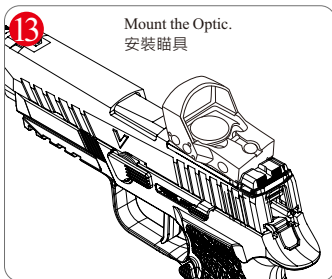
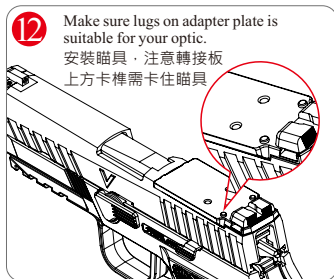

Be mindful screws that come with your optic are suitable with optic adapter. Incorrect size of screws will damage either optic or pistol.

請注意光學瞄具所附的螺絲是否合適於隨槍配置的瞄具轉接座。不適配尺吋的螺絲將會損傷光學瞄具或手槍。

2-1 Charging Of Gas / 填充瓦斯

- Keep hands and face at a safe distance from the escaping gas.
注意洩漏的瓦斯，避免肢體和臉部過於靠近。
- Escaping gas may cause icing.
洩漏的瓦斯可能會導致結霜。
- Gas may explode if exposed to temperatures exceeding 50 °C.
如果暴露在超過攝氏50度的溫度下，可能導致瓦斯氣體過度膨脹或爆炸。
Do not smoke, keep away from naked flames. The gas is highly inflammable.
瓦斯屬於高度易燃物質，填充瓦斯時，請勿吸菸並遠離火源及高溫處。

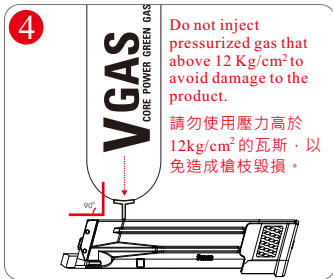
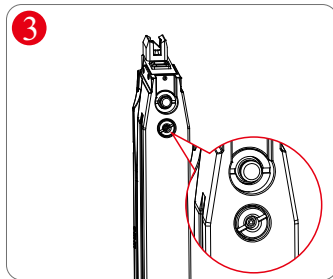
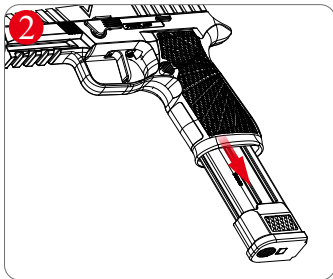
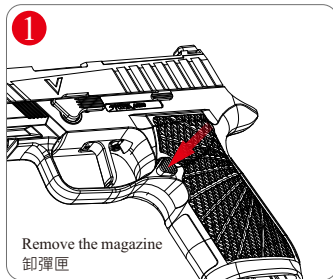

Keep the magazine with gas tank tilted. Attach the gas flask vertically to the charging port of the magazine. Press the flask against the port. The magazine is fully charged when you observe a discharge of gas from the port.

保持彈匣灌氣口與瓦斯罐接嘴的垂直；並將瓦斯罐接嘴對準並接上彈匣灌氣口，用力壓下開始填充；填充完成時彈匣灌氣口將會有些微瓦斯氣體溢出，此時將接嘴拔出灌氣口即完成瓦斯填充。

2-2 Discharging Of Gas / 釋放瓦斯

Hold the magazine at its bottom. Press the valve Residual gas may now be discharged.

握住彈匣並按下氣閥釋放鈕，瓦斯將從彈匣頂端釋放噴出。

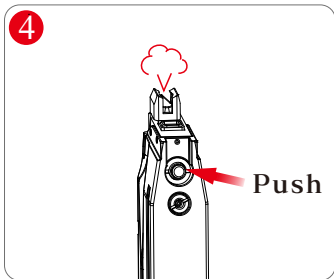
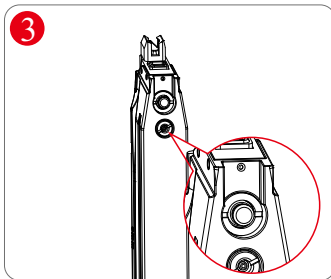
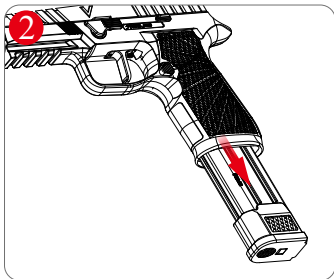
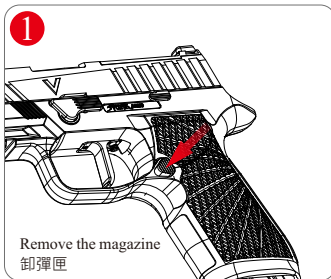

2-3 Loading The Magazine / 裝填BB彈

Always use the quality BBs for this airsoft gun. we will not be held responsible for any damage and accidents arising from using of bad quality BBs.

請使用原廠或品質良好的BB彈。若因使用劣質的BB彈造成玩具槍毀損，本公司不負相關保固之責任。



Never use the following BBs :

若BB彈出現以下狀況，請勿使用：



Diameter Larger Than 6mm

直徑大於6mm



Both Halves Not Aligned

有模線痕跡



No True Round Bbs

非真圓



With Flash

有裂紋或破損



Used Or Soiled

已使用過或表面髒污

1

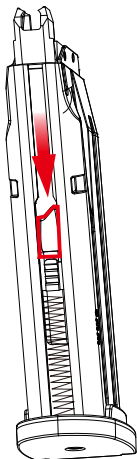

2

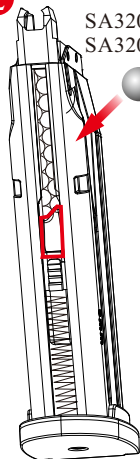

SA320 : 21Rds

SA320T : 26Rds

2-4 Shooting preparation / 射擊前準備

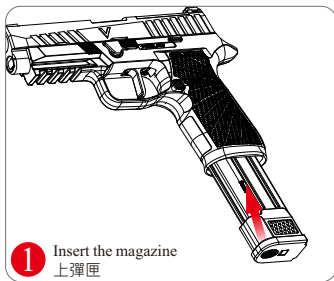

Only handle your gun in it's safe condition.

僅在安全條件下操作槍支。

Always make sure that the muzzle points in a safe dircetion.

始終確保槍口指向安全方向。

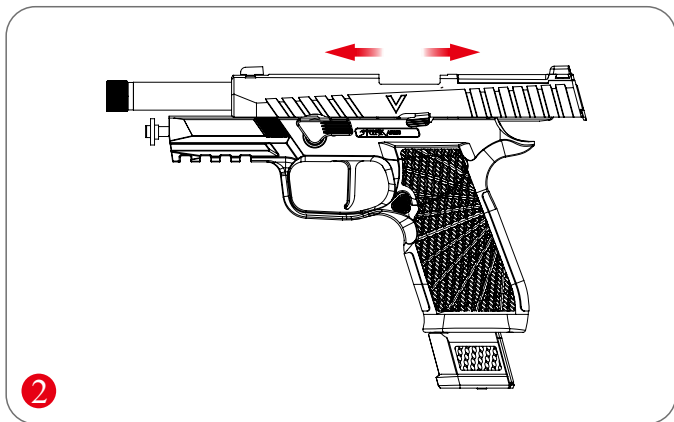

2-5 Sights / 瞄準

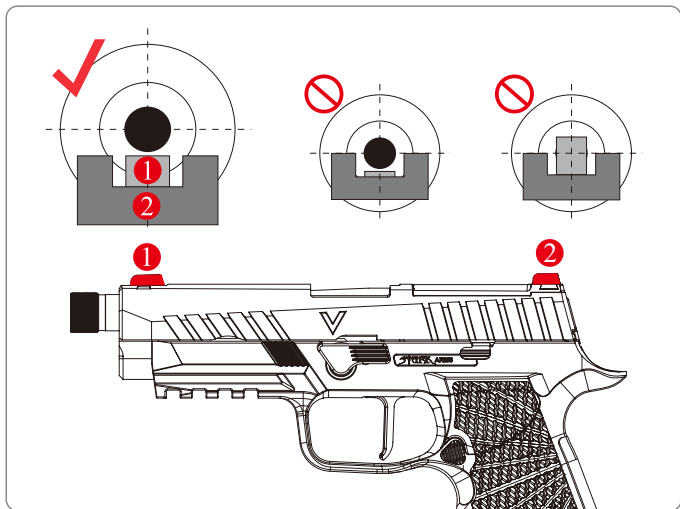

2-6 Shooting / 射擊

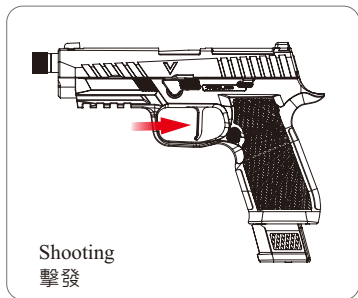

Only handle your gun in it's safe condition.

僅在安全條件下操作槍支。

Always make sure that the muzzle points in a safe direction.

始終確保槍口指向安全方向。

2-7 Adjustable Shoot Up / HOP-UP彈道調整

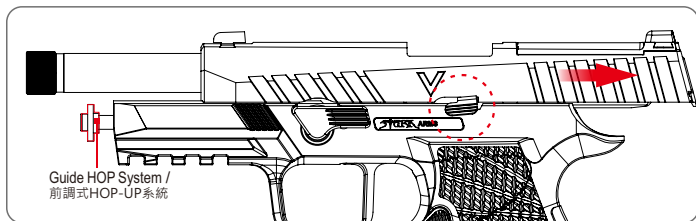

GuideHOP

The 1911 Ultra Carry II Gas Pistol adopts VFC's new patented "GuideHOP" adjustment design.

You can just rotate the spring guide directly for hop adjustment without any tool.

This kind of design makes you can adjust it anytime, anywhere, quickly and easily without any disassembly.

1911 Ultra Carry II 採用VFC最新專利的 "GuideHOP" 彈道調整設計。

無需任何工具，只要直接旋轉複進簧導桿即可進行彈道調整。

您可以隨時隨地、快速方便的調整，無需任何拆解，大大減少因拆解所造成的不便與毀損。

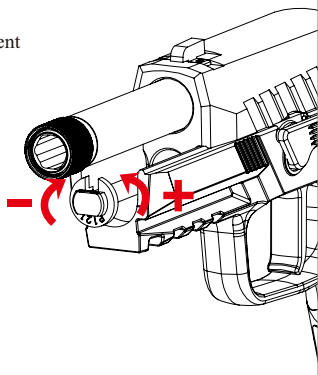

 + Too much hop-up / 調整過度

Best position /
最佳彈道

 - Not enough hop-up / 調整不足

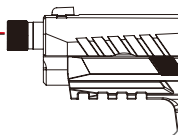

2-8 Shooting done / 射擊完畢

Only handle your gun in it's safe condition.

僅在安全條件下操作槍支。

Always make sure that the muzzle points in a safe dircetion.

始終確保槍口指向安全方向。

When finish the shooting / 射擊完畢

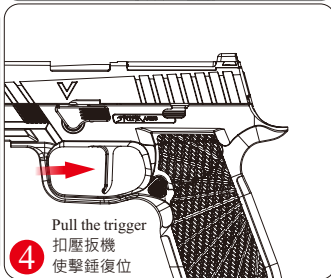
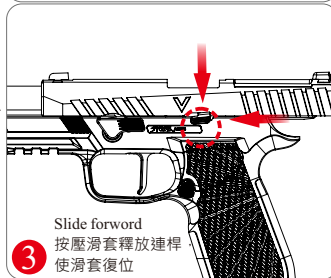
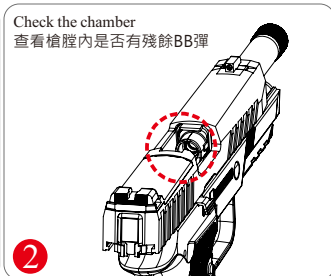
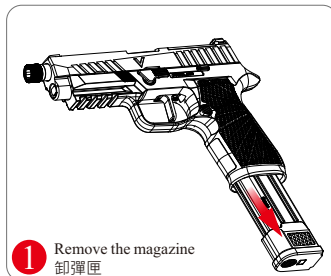

3-1 Cleaning and Maintenance / 清潔與保養

Use patch holder to clean the inner barrel.

使用通槍條清潔槍支內管。

Unload the gun before cleaning the gun.

清潔槍支前務必確認槍支沒上膛、彈匣卸下。

Do not force the rod into the barrel, as this could cause damage.

請勿將通槍條硬塞進槍管，以免造成槍支故障或損壞。

Occasionally clean the metal parts on the outside. Use a cloth which has been slightly dampened with some gun oil.

外部金屬零件只需使用些微沾濕槍油潤滑的布料擦拭即可。

Never drip silicone oil directly into the barrel.

請勿直接將槍油或保養油滴入槍管。

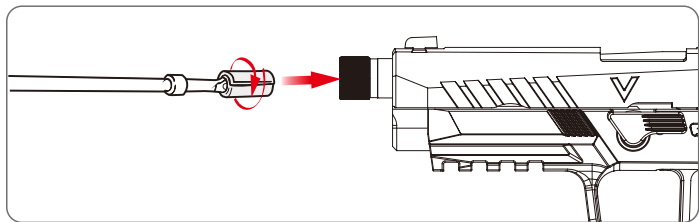

Put the safety on "safe". Prepare a thin rod with a length of approx. 30 cm. Attach a piece of cotton fabric to its end and clean the barrel with some silicone oil.

先將保險關閉，並準備長度約30公分的通槍條；以些微槍油潤滑乾淨的小片棉布，並纏在通槍條頂端，再插入槍管擦拭髒汙即可。

3-2 Trouble Clinic / 故障排除

	cock the magazine again / 彈匣安裝不正確	Magazine empty / 彈匣BB彈耗盡	Dirty barrel / 槍管髒汙	Extreme temperatures / 室溫過高或低	Wrong ammunition / 錯誤或劣質的BB彈	Ammunition badly loaded / 上彈不順或卡彈	Gas empty / 彈匣瓦斯耗盡
Faulty shooting direction 射擊表現異常		○	○	○	○	○	
Gun does not shoot 無法擊發	○	○		○	○	○	○
Low shooting speed 初速過低		○	○	○	○	○	
PROBLEMS 問題	POSSIBLE CAUSES 可能原因						

If you have any other states, please contact with your dealer or write the E-Mail for us service@vegaforce.com.tw

如果您有其它問題，請向您購買的經銷商聯繫或寄電子郵件至我們公司信箱service@vegaforce.com.tw

**1KG
PACK**

SUPREME PRECISION GRADE BBs

For Your Gas Rifle And Pistol 100% Made In Taiwan

Diameter
5.95mm
 $\pm 0.01mm$



Plastic Series



CERTIFICATIONS:

Biodegradable Test Report ISO 14855-1 in connection with DIN EN 13432

Certified EN71 part 3:2013

Compliant with ASTM D-6400-99 "Standard Specifications for Compostable Plastics"

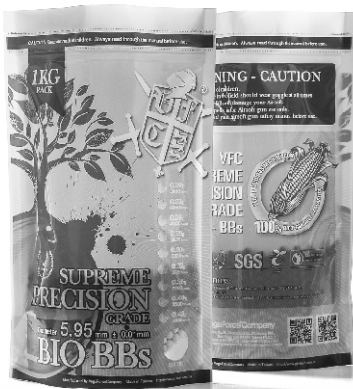

BIO Series



SA 320 SERIES

Gas Blowback Pistol, Cal. 6mm BB
Manufactured by VegaForceCompany
100% Made in Taiwan

Visit the product website for more details