



HECKLER & KOCH

NO COMPROMISE

MP5 SD3
EARLY MODEL

GAS AIRSOFT / cal. 6 mm

powered by **UMAREX** www.umarex.com

UMAREX HOLDS THE WORLDWIDE EXCLUSIVE HK-
TRADEMARK AND EXTERIOR DESIGN COPY LICENSE
FOR USE WITH THIS PRODUCT, GRANTED BY HECKLER
& KOCH GMBH. FOR SALE IN ASIA ONLY.



VF2-LMP5SD3-BK02 MP5 SD3

EN Operating instructions 2 - 8

CH 使用說明書 9 - 15



SAFE GUN HANDLING

EN



DESCRIPTION



OPERATION



MAINTENANCE



SAFETY INSTRUCTIONS

You should be fully familiar with the proper and safe handling of your gun. The basic principles of gun safety require you to always apply the following rules when handling the firearm.

Always treat a gun as if it was loaded.

Always put the safety of a gun to safe when loading it so that there can be no unintentional discharge.

Keep your finger away from the trigger. It should be straight and should rest on the trigger guard. Only use the kind of projectiles suitable for your gun.

Always keep the muzzle pointed in a safe direction.

This gun may only be discharged in your own house, on authorized shooting ranges and inside enclosed private property. It is to be made sure that no projectile can leave the enclosed property.

Keep the danger area of the projectile in mind.

Never transport a loaded gun. Only load your gun when you intend to fire it.

Never aim your airgun at persons or animals. Avoid ricochets. Never fire at smooth, hard surfaces or water.

Always make sure that the gun is not loaded when you transport it or take it from another person. Make sure that you always have full control over the muzzle of your gun, even if you stumble or fall down.

Safety shooting glasses should always be worn when firing the gun.

Always store your gun in a safe place and in unloaded condition. Unauthorized persons (persons not familiar with the use of guns, children) must not have access to it. Ammunition is to be kept in a separate place.

This gun and its instruction manual may only be passed on to persons

- who are fully familiar with its use and

- who have reached the legally stipulated minimum age in the respective country.

Modifications or repairs of guns are only to be effected by authorized agencies or by a skilled gunsmith.

Never leave a loaded gun unattended.

Only unloaded guns are to be handed over to another person.

REPAIR

A gun that does not work properly is dangerous. Do not attempt to repair this pistol if it needs service. Incorrect assembly could lead to dangerous malfunctions.

Caution: Repairs should only be completed by Umarex authorized centres.



SAFETY INSTRUCTIONS | WARRANTY

CAUTION

For your own safety and the safety of others, carefully read these instructions before using this gun. Buyers and owners must observe all rules concerning the use and ownership of air guns. Modifying this gun may result in a change of its classification under guns law and is therefore prohibited. In such cases the manufacturers warranty will immediately become void.

WARNING

Do not brandish or display this airgun in public - it may confuse people and may be a crime. Police and others may think this airgun is a firearm. Do not change the coloration and markings to make it look more like a firearm. That is dangerous and may be a crime.

WARRANTY

Vega Force Company(VFC) warrants the HK416A5 AEG against defects in materials and workmanship for a period of one month or 30,000 rounds BB bullets shoot from the date of original purchase.

Warranty coverage: Internal parts of gearbox. The cosmetic Parts and electric motor are not cover by warranty.

We inspect and test each product before delivery to customer. In warranty period, the repair service will be provide by ours certify technician after determine the problem or damage defects in materials and workmanship.

This warranty does not apply: (a) to damage caused by accident, abuse misuse, misapplication, or non-VFC products. (b) to a product or a part has been modified without the written permission of VFC or his agent to disassembly or modify by unauthorized person.

TECHNICAL DATA

item no.	VF2-LMP5SD3-BK02 MP5 SD3	
	MP5SD3	
System	GasAirsoft	
Caliber/Ammo	cal.6mmBB	
Energy	>1,5Joule	
Velocity	upto130m/swith0,20gBB	
Drive	Semi-Auto	Full-Auto
Colour	Black	
Rate of fire	-	800rate/min
Barrellength	355 mm	
Weight	3122 g	
max.Length	760 mm	
Magazinecapacity	30BBs	
Danger Distance	200 m	



DESCRIPTION

EN

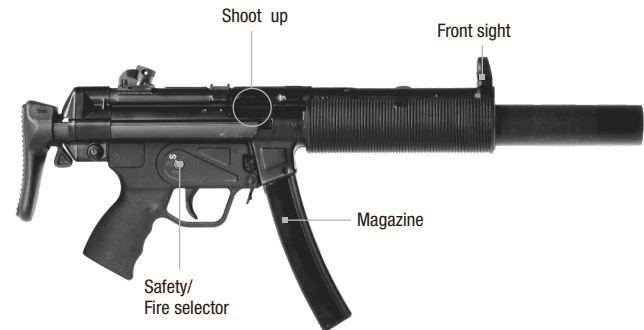



SAFETY / FIRE SELECTOR

EN

! CAUTION

- Only handle your gun in its safe condition.
- Always make sure that the muzzle points in a safe direction.

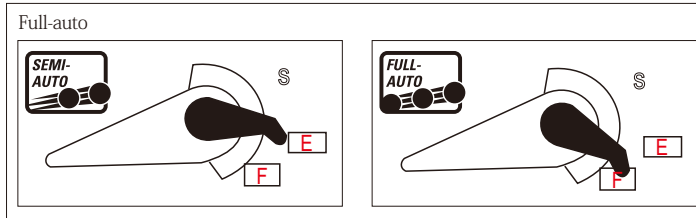
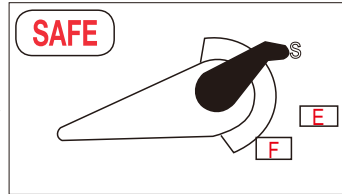

! CAUTION

please also always observe the legal regulations effective in your country for the use of arms.

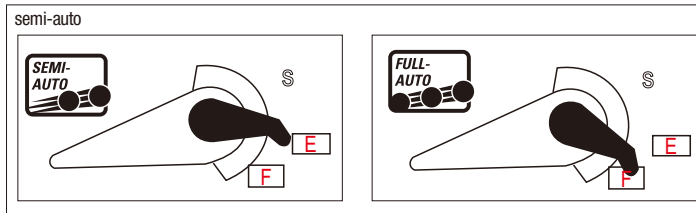

! CAUTION

- Please do not switch the fire selector while pulling the trigger. This causes severe damage to your weapon.



PROBLEM SOLUTIONS



PROBLEMS

- Faulty shooting direction
- Weapon does not shoot
- Low shooting speed

POSSIBLE CAUSES

	Safety activated	Gas empty	Dirty barrel	Extreme temperatures	Wrong ammunition	Ammunition badly loaded	Weapon not cocked	Sight not properly adjusted
Faulty shooting direction			●	●	●	●		●
Weapon does not shoot	●	●			●	●	●	
Low shooting speed			●	●	●	●		



LOADING THE MAGAZINE

EN

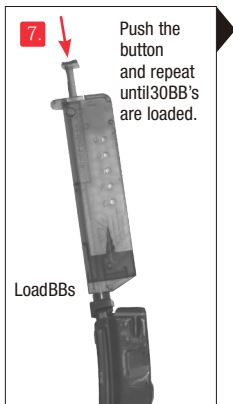
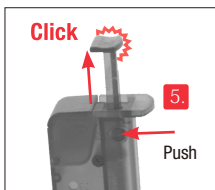
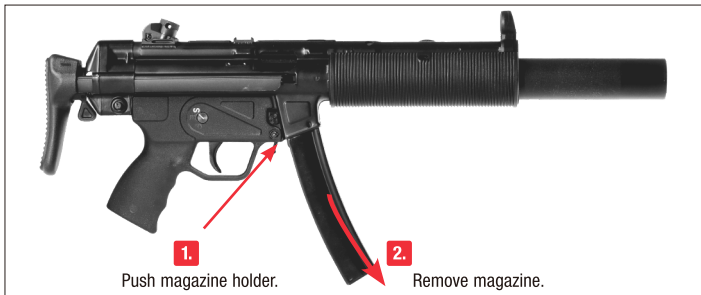

CAUTION

Only Use Flawless BBs: Never Use The Following BBs :
1 diameter larger than 6mm, **2** with edges, **3** both halves not aligned, **4** used, soiled.
 Warranty expires if non-recommended BBs are used.
 It's recommended to use precision BBs from UMAREX/WALTHER. To ensure proper operation of the magazine, protect it from dirt and dust.

30
ROUNDS

6 mm
AIRSOFT

WEIGHT
0,2 g BB

WEIGHT
0,25g BB





CHARGING OF GAS

⚠ CAUTION

- Keep hands and face at a safe distance from the escaping gas.
- Escaping gas may cause icing.
- Gas may explode if exposed to temperatures exceeding 50°C.
- Do not smoke, keep away from naked flames. The gas is highly inflammable.



Press the magazine holder.
Pull out the magazine.

NOTE

Keep the magazine with gas tank tilted. Attach the gas flask vertically to the charging port of the magazine. Press the flask against the port. The magazine is fully charged when you observe a discharge of gas from the port.



REMOVING OF GAS
Hold the magazine at its bottom. Press the valve. Residual gas may now be discharged.



ADJUSTABLE SHOOT UP

EN

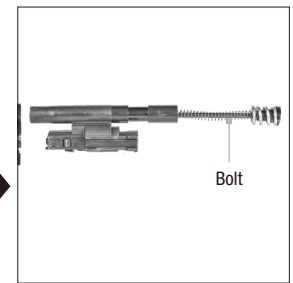
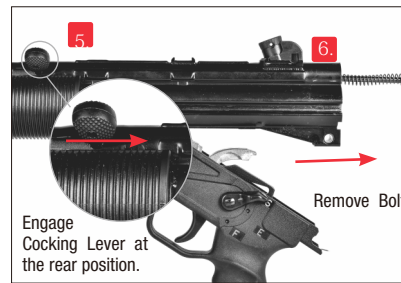
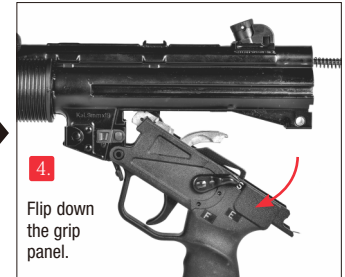
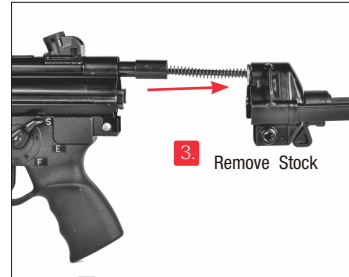
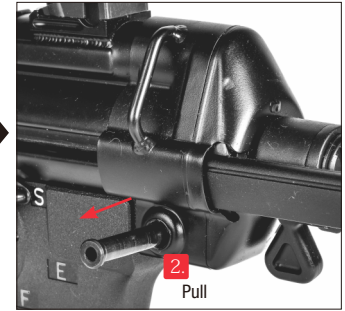
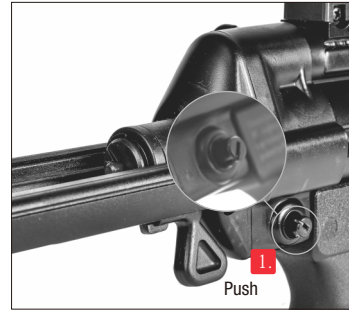



ADJUSTABLE REARSIGHT

EN

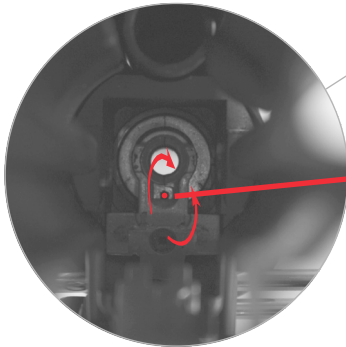
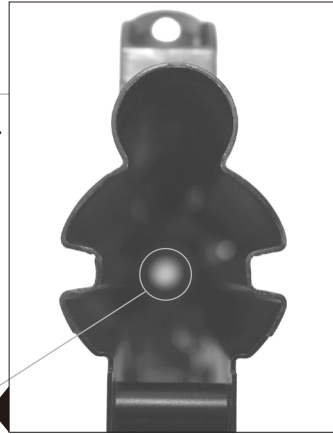

1.5mm Allenkey

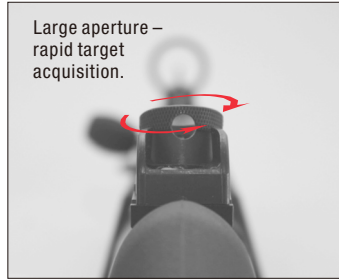

Large aperture – rapid target acquisition.



Small aperture – precise shooting.

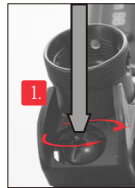

Loosen lug screws.

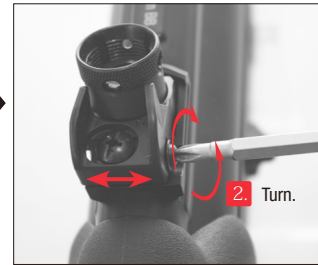

2. Turn.

Windage adjustment

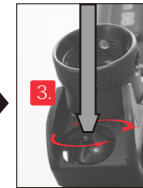

3. Tighten the fixing screw.

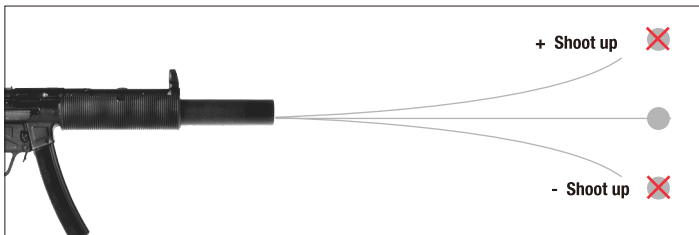

+ Shoot up X

- Shoot down X

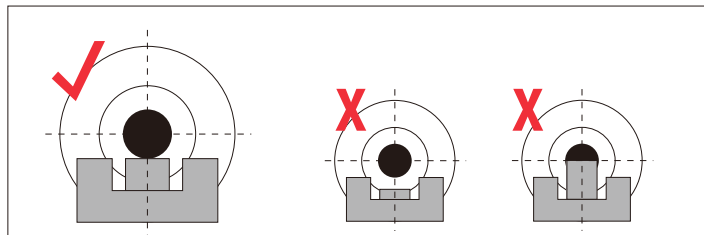



STOCK

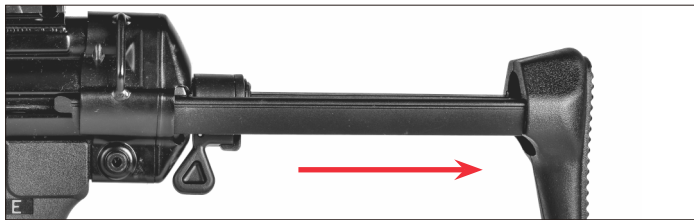

FIRING



BARREL CLEANING

EN

CAUTION

- Adjust the shoot up in normal position, before cleaning the weapon.
- Do not force the rod into the barrel, as this could cause damage.
- Occasionally clean the metal parts on the outside. Use a cloth which has been slightly dampened with some weapon oil.
- Never drip silicone oil directly into the barrel

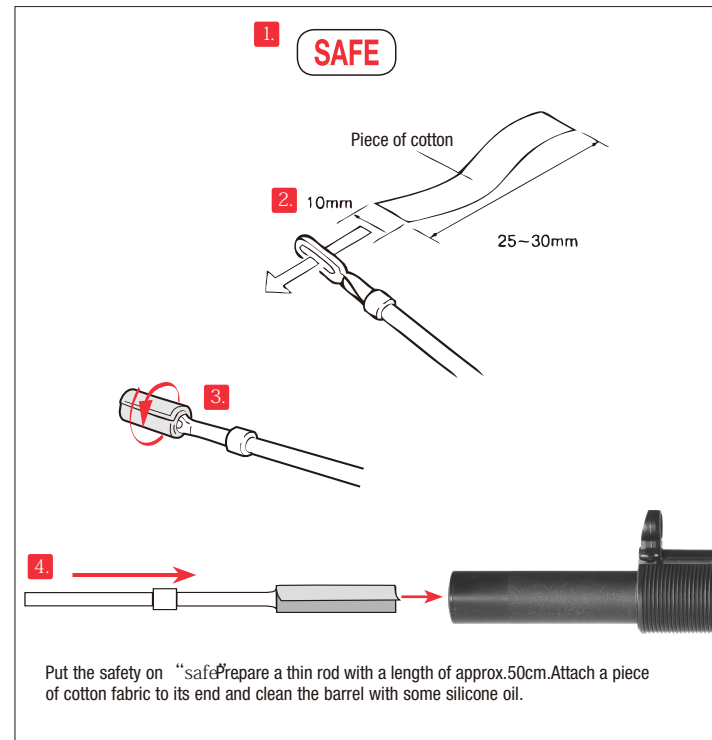



用槍安全守則

CH



使用描述



操作說明



保養方式



安全規範

操作本產品之前，請務必詳讀此操作手冊。
您必須完全的了解和熟悉如何安全的使用槍械，並且確實遵守以下的基本安全守則。

- 本產品及其說明書只能給予符合以下資格之他人：
—熟悉本產品的操作及使用，並達到當地法律允許的合法年齡。
- 使用時，請務必戴著合格的護目鏡等護具。
- 永遠假設槍內已有子彈上膛。
- 隨時保持槍支處於關保險狀態，以避免意外走火的情況。
- 除了真正射擊時，手指不得放在扳機上，應該伸直放在護弓外側。
- 請隨時將槍口指向安全的區域。
- 請在合法的安全場所、經過認證的靶場或是私人住家內使用本產品；並確保任何發射物都不會被發射至安全範圍之外。
- 開始射擊前，確定目標後方和周邊環境都安全無虞。
- 嚴禁將槍口指向人或動物，並避免射擊光滑堅硬的物體及水面，以免造成跳彈。
- 本產品只能發射標準的6mmBB彈，切勿使用其他發射物。
- 請隨時注意發射物的射程範圍。
- 在拿取、攜帶或運送過程中切勿上膛槍支，只有在準備射擊時才能上膛。
- 不可將上膛的槍支放在無人看守的範圍外。
- 你必須能隨時控制槍口的安全指向，包含在移動和臥倒時。
- 儲藏時，槍支不可上膛並需置放在安全或附鎖的位置。不可讓他人(包含不熟悉操作者、嬰孩及未達法定年齡的兒童等)未經允許的取得；BB彈必須分開儲藏在不同位置。
- 產品故障或損壞時，請與合法的經銷商或原廠授權的維修人員聯繫，切勿自行拆解、更換或修改零配件。

故障及維修

槍支故障時依舊有危險性，請不要試圖自行拆解或維修，錯誤的安裝或更換零件可能導致危險或槍支毀損。

注意：維修需求請與授權經銷商或原廠維修人員聯繫。



安全規範 / 售後服務

注意

為了您自身與他人的安全，操作本產品前，請務必詳讀此說明書。經銷商和持有人都必須遵守所有當地的法律及使用責任，任意變造或修改槍支是抵觸法律的行為，並直接影響到您所購買的產品的保固狀況。

警告

請勿在公開場合揮舞或展示槍支，且不可移除槍支的原廠標示色彩及刻印，以免造成執法人員及他人的誤解，造成恐慌；相關行為可能觸犯當地法律。

有限保固聲明

- 本產品自購買日起，本公司提供一個月或30,000發的有限保固(以先到達條件者為準)。
- 本產品經過嚴密之檢查與試驗，在保證期間內產品因正常使用而發生故障，經本公司認證之技術人員確認為製造或材料上之瑕疵時，本公司將負責免費維修。
- 以下情形，本公司將不負責保證責任：
 - 非本公司認證之技術人員修裝而導致之故障。
 - 外觀或內部構造經變更所導致之故障。
 - 經查驗非本公司經銷商所銷售之槍型，無法提供註冊卡及經銷商蓋印章者。
 - 因火災或其他天災、自然因素所導致之故障。

產品諸元

產品品號	VF2-LMP5SD3-BK02 MP5 SD3
	MP5SD3
動力系統	瓦斯覆進空氣槍
口徑 / 發射物	6mm BB彈
動能	1.5焦耳(J)
槍口初速	130m/s(使用0.2g BB彈)
射擊檔位	半自動及全自動
顏色	黑色
循環射速	每分鐘800發(rpm)
槍管長度	355 mm
重量	3122 g
全槍長度	760 mm
彈匣裝彈量	30發 BB彈
最大危險範圍	200 m



各部名稱

CH

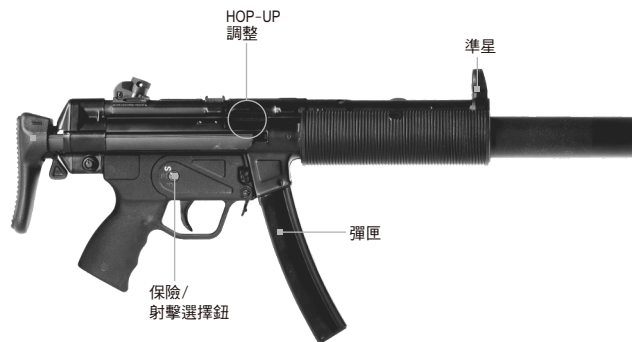



保險/射擊選擇鈕操作

⚠ 注意

- 請在安全的環境中使用槍支。
- 操作時請務必隨時注意槍口指向安全的區域。

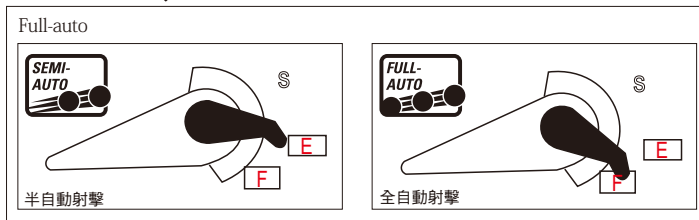
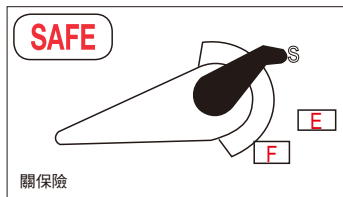

⚠ 注意

- 請隨時注意您所在國家或地區對於槍械玩具的管制及法律。

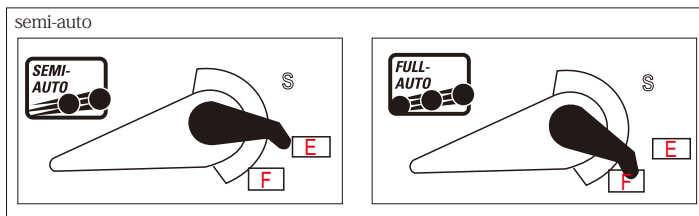

射擊

CH

⚠ 注意

- 請勿在扣扳機時同時操作保險/射擊選擇鈕的切換，可能導致機械結構受損。



故障排除



問題

- 射擊表現異常
- 無法擊發
- 初速過低

POSSIBLE CAUSES

	保險開關位置	彈匣瓦斯/BB彈耗盡	槍管髒汙	室溫過高或低	錯誤或劣質的BB彈	上彈不順或卡彈	槍支未上膛	準星未歸零
射擊表現異常			●	●	●	●		●
無法擊發	●	●			●	●	●	
初速過低			●	●	●	●		



裝填BB彈

CH



⚠ 注意



請使用原廠或品質良好的BB彈；並避免以下的狀況：

1 直徑大於6mm。 **2** 有裂紋或碎彈。 **3** 非真圓或有模線痕跡。 **4** 已使用過或表面髒汙。保固不包含對於使用低劣品質BB彈造成的故障；建議您選購VFC原廠或是其他高品質的產品。為確保彈匣的穩定運作及射擊效果，請保持彈匣及BB彈遠離髒汙及塵土。





填充瓦斯

⚠ 注意

- 注意洩漏的瓦斯，避免肢體和臉部過於靠近。
- 瓦斯洩漏可能導致結霜。
- 溫度超過攝氏50度時，可能導致瓦斯氣體過度膨脹或爆炸。
- 瓦斯為易燃物，請勿在填充時吸菸或將彈匣靠近火源及高溫處。

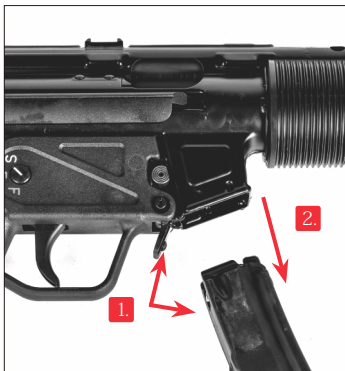

1. 按下彈匣釋放鈕。
2. 取下彈匣。
3. 保持彈匣灌氣口與瓦斯罐接嘴的垂直；並將瓦斯罐接嘴對準並接上彈匣灌氣口，用力壓下開始填充；填充完成時彈匣灌氣口將會有微瓦斯氣體溢出，此時將接嘴拔出灌氣口即完成瓦斯填充。



釋放瓦斯

握住彈匣並按下此氣閘釋放鈕，瓦斯將從彈匣頂端釋放噴出。



HOP-UP彈道上旋調整

CH



壓下彈簧鎖。



拉出彈簧鎖。



取出槍托



順此方向拉開整個握把組。



將槍機拉柄往後拉，並些微轉上溝槽固定。

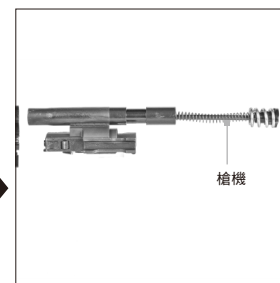

槍機



機械瞄具調整

CH

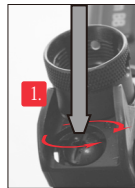
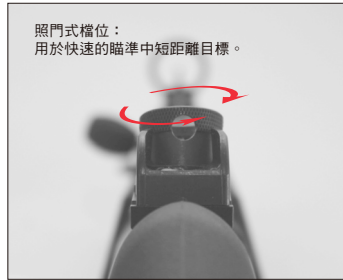
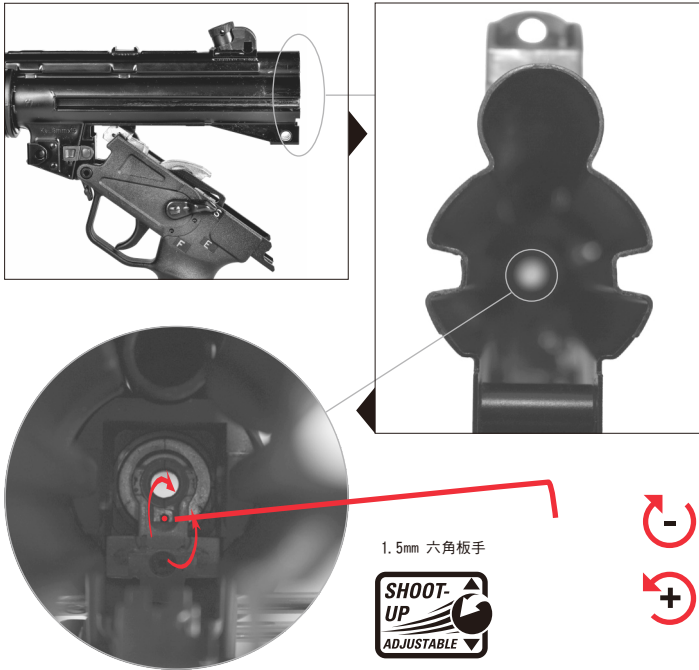

鬆開固定螺絲。



從側面螺絲調整瞄具。

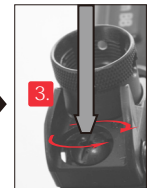

調整完成後再度鎖緊固定螺絲。

歸零調整：

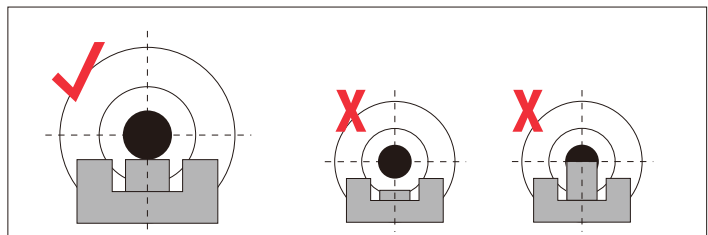
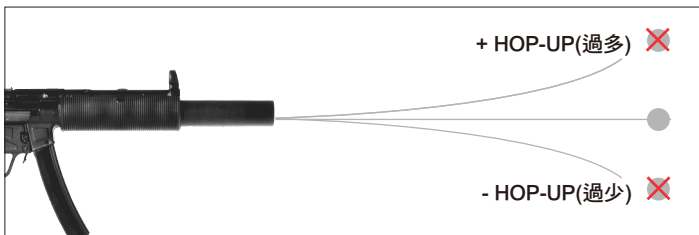

槍托

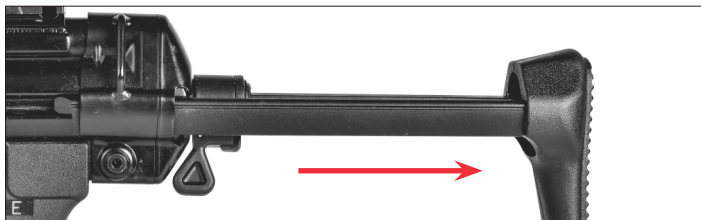

上膛及射擊



清潔槍管

CH

注意

- 清潔槍支前務必確認槍支沒上膛、彈匣卸下。
- 請勿將通槍條硬塞進槍管，以免造成槍支故障或損壞。
- 外部金屬零件只需使用些微潤滑的布料擦拭即可。
- 請勿直接將槍油或保養油滴入槍管。

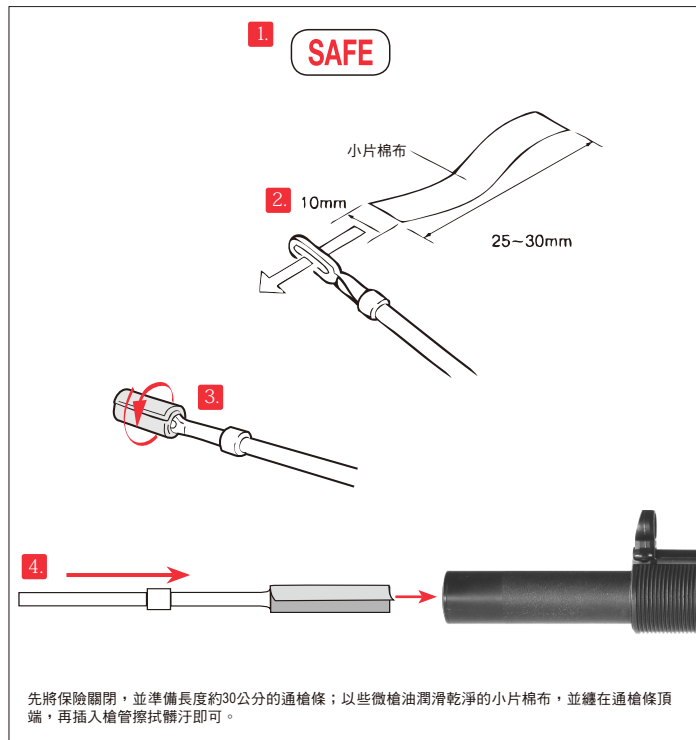

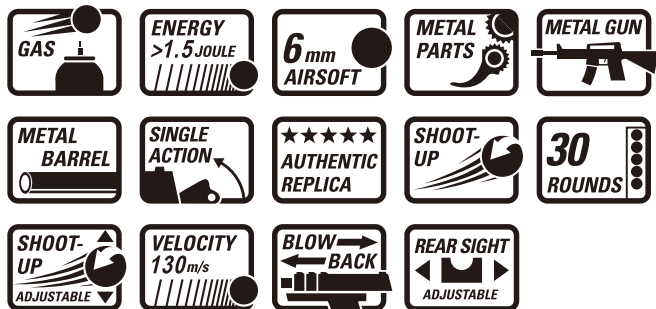

VegaForce Company
www.gb-tech.com.tw

8F., No.609, Sec. 1, Wanshou Rd., Gueishan Dist.,
Taoyuan City 333, Taiwan (R.O.C.)
Phone: +886 - 2 - 8200 - 6630
Fax: +886 - 2 - 8200 - 6631
e-Mail: service@vegaforce.com.tw

We reserve the right to make color and design changes and technical improvements. No responsibility is accepted for printing errors or incorrect information.

我們保留修改說明書版面及更新內容說明的權利，不承擔任何對於印刷差異及版本修正的責任。