



HI-CAPA CHALLENGER

Please read the [Instruction Manual] carefully and make full understanding of the details noted in the contents before use.

WARNING

- To avoid damaging the product, please release the gas from the magazines or cartridges while not operating.
- Sales and usage are restricted to 18-year-old people or older. Those below 18 years old are not allowed neither to purchase nor to operate alone.
- Never aim or shoot at people or animals. Please beware of childrens' mis-handling.
- Please read and fully understand all details listed in this instruction manual before using this air gun. You can download it from www.icsbb.com if you lose this instruction manual.

6mm BB



1 PART DESCRIPTION

WARNING-ATTENTION

This model is featured with Gas-Blow-Back function. The slide will be pushed backward by the gas pressure strongly and rapidly while firing. **To prevent injury, please keep your face and finger away from the slide.**

- The pistol could be damaged when using at temperature of 40° C (104° F) or above.

2 SAFETY DEVICE

Safety ON
Engage the safety by cocking down the hammer then pressing up on the safety lever.
* The trigger and slide can not be pulled when the safety is engaged.
* Please press up the safety lever only when the hammer is cocked, or damage might be caused.

Safety OFF
Disengage the safety when you are going to fire.

- The trigger cannot be pulled without holding the grip safety.
- The trigger can be pulled when holding the grip safety firmly.

3 LOADING MAGAZINE

WARNING-ATTENTION

- To prevent misfiring, keep your finger off the trigger and out of the trigger guard while loading the magazine.
- For safety reason, please remove the magazine while not operating.

Load the magazine until it clicks into the locking position.
* Do not insert the magazine by force.

Release the magazine by pressing the magazine catch button.
* Hold the magazine when releasing it from the pistol grip to prevent it from dropping.

4 CHARGING GAS

For the optimum product performance, please charge your magazine with 10-12kg airsoft use green gas. If you use green gas with non-recommended number of kg, it may cause damage or malfunction to the product.

WARNING-ATTENTION

Please avoid to touch the injection hole. It might cause frostbites or low temperature burns if the gas adheres to the skin.

To preserve the magazine
Magazines are very delicate parts, dropping them may cause damage or abnormality.
Please avoid foreign matter remains on the magazine lip and injection hole on the magazine, which may cause abnormality.
If refilling is necessary, please avoid to proceed when the magazine is loaded. Please unload the magazine before proceed.
Placing magazines in wet places or accumulated water may lead to abnormalities.

Precautions while filling:
* If you fill the magazine with a non-vertical way from up towards down, and caused the magazine is not completely filled, please deflate the gas completely, and refill the gas one more time as instructed.
* Fill the gas until the gas starts to leak out. When the gas is fully filled, gas inside the gas canister and magazine are balance without refilling anymore. It is the normal condition that the gas starts to leak out because it is not able to keep filling. Please stop filling immediately.
* Please use your magazine under normal temperature!
* If you operate in environment of 20° C or below, the gas pressure will drop and might cause abnormal functions. (The magazine will work normally again when temperature returns to normal temperature.)
* If operate in environment of 40° C or above, the gas pressure will be too high and might cause abnormal functions. (The magazine will work normally again when temperature returns to normal temperature.)
* If you fill the magazine with gas and fire dozens of shots even under normal temperature, the gas pressure will also drop and cause the gas temperature to drop. Prepare several spare magazines for exchange is recommended.

It is incorrect to refill with the canister nozzle aligned vertically to the magazine base plate.

Please turn the magazine up side down to keep the injection hole side up, fill the gas only when the canister is verticalized to the injection hole.
* The gas will not be filled into the magazine or will leak out if the canister is not verticalized to the injection hole.

5 LOADING BBs

Leave no gap between BBs

WARNING-ATTENTION

- Do not release the magazine follower abruptly while pressing the follower. Releasing the follower carelessly may damage the magazine lip.

Pull the magazine follower down to the end, insert BBs into the BB slot. (30 rounds MAX)

You may insert the last BB through the magazine lip.
* Do not attempt to insert more than 30 BBs into the magazine.

6 Trigger Pull Adjustment

Please use a 2mm Allen wrench to adjust the trigger pull hex screw.
* Please adjust according to personal habit.
* The trigger could be locked by fastening the hex screw to the end, please release the screw properly.

7 Loading

WARNING-ATTENTION

- Keep your face and fingers away from the slide while the slide is operating.
- When the magazine is detached, the slide stop will not lock the slide spontaneously after your releasing the slide.
- When the pistol is loaded, loading repeatedly will makes the BBs load into the barrel repeatedly, which will lead to malfunction while firing and cause danger.
- When the hammer is pressed down, pulling the trigger will fire the bb. Please take extra notice.

8 SHOOTING

- Switch the safety to FIRE.
- Load the pistol according to step 7.
- Pull the trigger to fire (a BB pellet will be fired and the slide will be pushed backward).

The slide will be blown back and forth when firing.

WARNING-ATTENTION

- Power Depression
When the temperature inside the magazine is too low, the gas power will be depressed.
The movement of the slide will be delayed.
The slide catch will not bounced.
The shooting range will not be far.
- Shooting posture
Please do not operate the pistol up side down for optimum performance.

To prevent misfiring, keep your finger off the trigger and out of the trigger guard when you are not ready to fire.

When the BB is loaded into the barrel, the following process will be proceeded and repeat automatically everytime you pull the trigger:
BB fired → Slide movement (blowed backward) → Load the next BB (slide re-positioned)

* ATTENTION
* The rails on the slide is very sharp. Please keep your face and fingers away from the slide while the slide is operating.
* Please keep your finger off the trigger and out of the trigger guard, and take extra caution to where the gun is aiming while proceeding non-firing operations.

9 STORAGE

- Press the magazine catch button to release the magazine.
- Make sure the inner barrel is clear. If not, pull the slide backward, and turn the pistol up side down to remove (push the BB pellet out from the barrel by the clearing rod is also recommended).
- Press the slide catch lever to release the slide.
- Pull the trigger and fire several times towards safety directions, and make sure no BBs are left inside the barrel.

10 DISASSEMBLY (Do it when necessary)

Only disassemble your airsoft replica when adjusting the H-UP and proceeding to maintenance.

① Press the Magazine Release Button to unload the magazine.

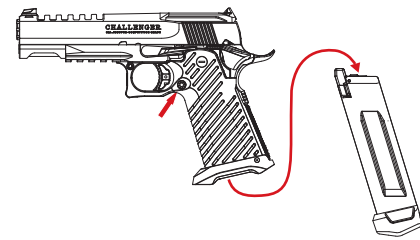

② Pull back the slide and press the slide stop upward to lock it.
③ Insert the dedicated tool into the hole on the recoil spring guide as shown.

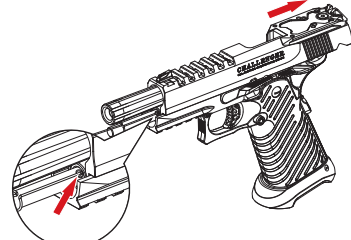

④ Push the Slide backward and align the notch corresponds to the slide stop as shown.

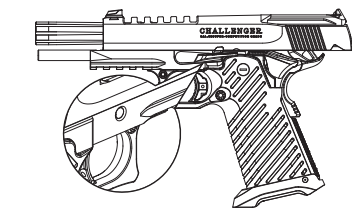

⑤ Press the slide stop button on the right to remove it.
⑥ Push the slide forward to detach it. Meanwhile, The recoil spring guide set is contained.
⑦ The recoil spring guide set can be easily removed by slightly pushing it forward and taking it out.
⑧ Push the outer barrel set forward to remove. You may disassemble the recoil spring guide by detaching the dedicated tool if necessary.

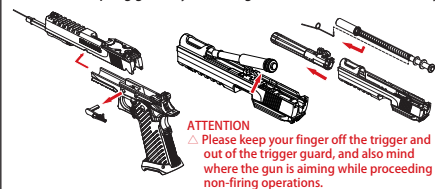

ATTENTION
△ Please keep your finger off the trigger and out of the trigger guard, and also mind where the gun is aiming while proceeding non-firing operations.
△ Watch out for the rod may bounce out of the recoil spring guide set.

11 H-UP ADJUSTMENT

① Please disassemble and remove the slide as step 10 instructed.
② Slightly rotate the screw to adjust the H-UP.

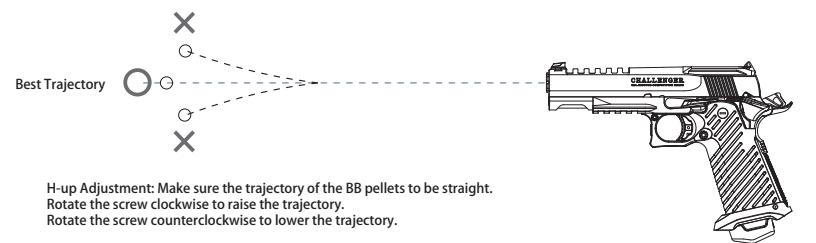
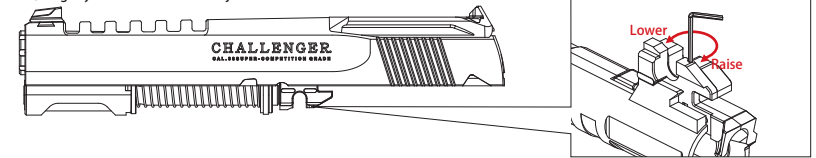

H-up Adjustment: Make sure the trajectory of the BB pellets to be straight.
Rotate the screw clockwise to raise the trajectory.
Rotate the screw counterclockwise to lower the trajectory.

12 ASSEMBLY

※ Please check the following status before assembly:
△ The hammer must be down pressed.

① Insert the dedicated tool into the hole on the rod and reverse Step 10, to assemble the recoil spring guide set.
② Assemble the outer barrel set by pushing it back into the slide.
③ Assemble the recoil spring guide set to the slide.

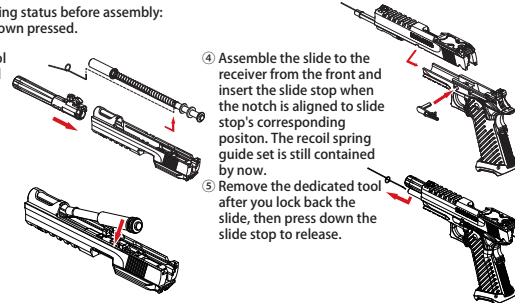

④ Assemble the slide to the receiver from the front and insert the slide stop when the notch is aligned to slide stop's corresponding position. The recoil spring guide set is still contained by now.
⑤ Remove the dedicated tool after you lock back the slide, then press down the slide stop to release.

WARNING-ATTENTION

● ICS will not be responsible for any part assembling errors, missing parts, and issues such as malfunctions, accidents, injuries. All the maintaining expenses will be borne by the customers.

13 BASIC TROUBLESHOOTING GUIDE

SYMPTOMS	POSSIBLE CAUSES	SOLUTIONS
No Response	The safety is ON. (No firing)	Switch the safety to "OFF" (refer to step 2)
	Magazine overpressured.	Press the valve gently to release gas and to adjust pressure. Be careful when gas discharges from the nozzle seal.
	Insufficient gas inside the magazine.	Charge gas into magazine (refer to step 4)
The slide blows back but no BB is fired.	BB can't be loaded into the barrel.	Load the first BB into the barrel (refer to step 7)
	BB is jammed inside the magazine.	Push out the BB by using the clearing rod, or pull the slide backward, and turn the pistol up side down to remove.
	Magazine is too cold.	Use the magazine after it is returned to normal temperature (refer to step 4).
Magazine is too cold.		
Will not complete cycle	No gas in the magazine.	Charge gas into magazine (refer to step 4)
	Lubricant or silicon oil is not enough.	Apply lubricant to the moving parts.
	Slide jammed	Remove the BBs or foreign matters. Press the slide stop downward to release the Slide.
Gas comes out from the barrel	Temperature is too low.	Use the magazine after it is returned to normal temperature (refer to step 4).
	Magazine is too cold.	
BBs fly up	H-UP is over adjusted.	Rotate the H-UP screw counterclockwise.
Shooting range is too short	H-UP isn't adjusted enough.	Rotate the H-UP screw clockwise.
	Foreign matters or oil in the inner barrel.	Clean the inner barrel and H-UP bucking.
BBs roll out of barrel	H-UP isn't adjusted enough.	Rotate the H-UP screw clockwise.
	Jammed	Rotate the H-UP screw counterclockwise.
	Bad BBs, oversize BBs	0.2g to 0.25g 6mm caliber BBs are recommended for optimum performance.
	Foreign matters or oil in the inner barrel.	Clean the inner barrel.

14 PARTS DIAGRAM

*The components/accessories for each model may have kind of differences depending on the actual goods. Images are only for reference.

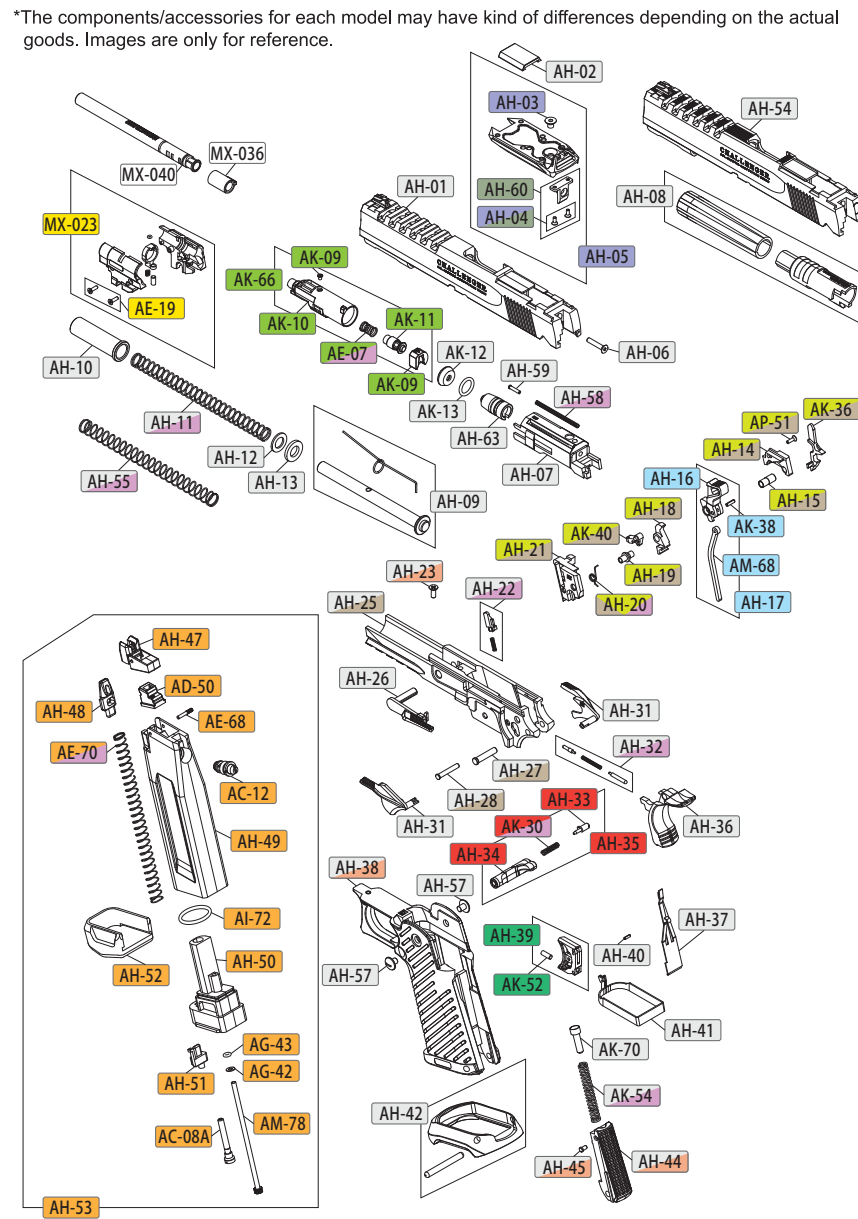

15 PARTS DESCRIPTION

ITEM#	DESCRIPTION	Q'TY	ITEM#	DESCRIPTION	Q'TY
AH-01	Hi-Capa Slide with Front Sight	1	AH-54	Hi-Capa Plastic Slide with Front Sight	1
AH-02	Hi-Capa Slide Cover	1	AH-55	Hi-Capa Recoil Spring	1
AH-03	Hi-Capa Rear Sight Screw	1	AH-56	Hi-Capa Spring Pack	1
AH-04	Red Dot Hammer Protection Pad Screw	2	AH-57	Hi-Capa Grip Screw	2
AH-05	Hi-Capa RMR & DOC Mount	1	AH-58	Hi-Capa Cylinder Housing Spring	1
AH-06	Hi-Capa RMR & DOC Mount Screw	1	AH-59	Hi-Capa Cylinder Housing Spring Pin	1
AH-07	Hi-Capa Cylinder Housing	1	AH-60	Mount Hammer Protection Pad incl. Screw	1
AH-08	5.1" Hi-Capa Outer Barrel	1	AH-63	Hi-Capa Cylinder Cover Housing	1
AH-09	5.1" Hi-Capa Recoil Spring Guide Rod with Reverse Plug Retention Clip	1	AC-08A	Revo Quantitative Gas Injection Valve	1
AH-10	Hi-Capa Recoil Spring Guide	1	AC-12	Revo.II Efficient Gas Release Valve	1
AH-11	Hi-Capa Recoil Spring	1	AD-50	XPD Magazine Nozzle Seal	1
AH-12	Hi-Capa Shock Buffer Washer	1	AE-07	XAE Valve Spring	1
AH-13	Hi-Capa Shock Buffer Rubber	1	AE-68	XAE Magazine Lip Pin	1
AH-14	Hi-Capa Hammer Housing-Right	1	AE-19	XAE H-UP Chamber Screw	2
AH-15	Hi-Capa Hammer Sleeve	1	AE-70	XAE Magazine Follower Spring	1
AH-16	Hi-Capa Hammer	1	AG-42	Washer	1
AH-17	Hi-Capa Hammer Combination	1	AG-43	Screw O-Ring	1
AH-18	Hi-Capa Sear	1	AH-09	Vulture Valve Cover with Screw	1
AH-19	Hi-Capa Sear Sleeve	1	AK-10	Vulture Cylinder	1
AH-20	Hi-Capa Hammer Knocker Spring	1	AK-11	Vulture Valve	1
AH-21	Hi-Capa Hammer Housing-Left	1	AK-12	Vulture Valve Plate	1
AH-22	Hi-Capa Hammer Disconnect with Spring	1	AK-13	Cylinder Cover Housing O-Ring	1
AH-23	Hi-Capa Middle Frame Screw	1	AK-30	Vulture Magazine Catch Spring	1
AH-25	Hi-Capa Middle Frame	1	AK-36	Vulture Hammer Disconnect Pin	1
AH-26	Hi-Capa Slide Release	1	AK-38	Hammer Brace Rod Pin	1
AH-27	Hi-Capa Hammer Pin	1	AK-40	Vulture Hammer Knocker	1
AH-28	Hi-Capa Sear Pin	1	AK-52	Vulture Trigger adjustment Screw	1
AH-29	Hi-Capa Middle Frame Combination	1	AK-54	Hammer Spring	1
AH-30	Hi-Capa Hammer Housing Combination	1	AK-66	Vulture Cylinder Combination	1
AH-31	Hi-Capa Slide Safety	1	AK-70	Vulture Hammer Spring Holder	1
AH-32	Slide Release Pin and Spring	1	AM-68	BM9 Hammer Brace Rod	1
AH-33	Hi-Capa Magazine Catch Lock	1	AI-72	Magazine Base O-Ring	1
AH-34	Hi-Capa Magazine Catch	1	AM-78	Magazine Base Screw	1
AH-35	Hi-Capa Magazine Catch Combination	1	AP-51	PM2 Magazine Cover Screw	1
AH-36	Hi-Capa Grip Safety	1	MX-023	Master Hi-Capa TDC Hop Chamber	1
AH-37	Hi-Capa Sear Spring	1	MX-036	Master Ver.2 R-Hop Chamber Rubber FOR GBB	1
AH-38	Hi-Capa Grip	1	MX-040	Master Inner Barrel 113mm FOR AEG/GBB	1
AH-39	Hi-Capa Trigger	1			
AH-40	Hi-Capa Trigger Bar Pin	1			
AH-41	Hi-Capa Trigger Bar	1			
AH-42	Hi-Capa Magwell & Pin	1			
AH-44	Hi-Capa Hammer Spring Housing	1			
AH-45	Hi-Capa Hammer Spring Lock Pin	1			
AH-46	Hi-Capa Grip Combination	1			
AH-47	Hi-Capa Magazine Lip	1			
AH-48	Hi-Capa Magazine Follower	1			
AH-49	Hi-Capa Magazine Case	1			
AH-50	Hi-Capa Magazine Base	1			
AH-51	Hi-Capa Magazine Plate Stop	1			
AH-52	Hi-Capa Magazine Plate	1			
AH-53	Hi-Capa Magazine	1			